

MyGica®

ATV 329_X



Quick Start Guide

Quick Setup Guide



- 1. Power Button
- 2. SD Card Slot

- 3. USB Port
- 4. DC Input



- 5. CVBS Port
- 6. HDMI Port

- 7. LAN Port



CVBS Cable



HDMI Cable



Power Adapter



Remote Control

Please do not return to the store, we are here to help. Our contact information is listed on the back of this manual. MyGica will make sure you have what you need as soon as possible.

Connect Power and HDMI

Place the ATV329X on a flat platform near the TV and connect your HDMI cord. If you require an Ethernet connection, you should do this before powering on.

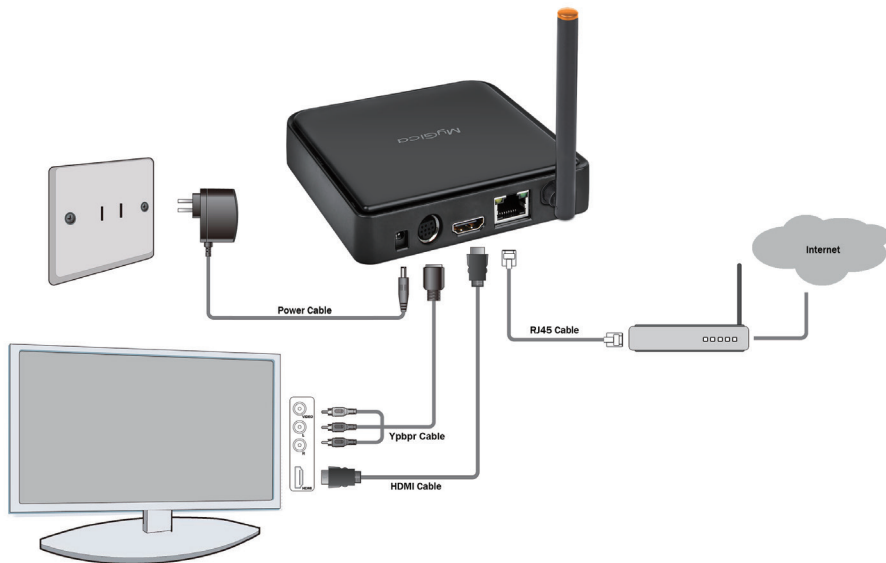

KR-41 Remote

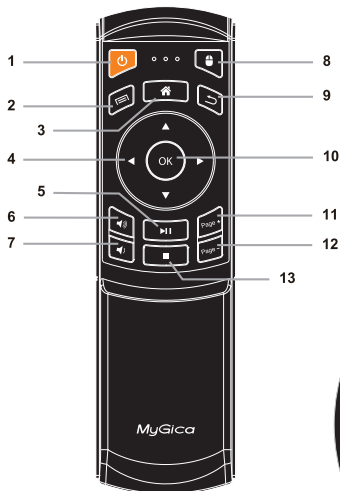

Important

Please make sure the USB receiver is connected to ATV329X before you use the remote.



- | | | | | |
|------------|------------|----------|-------------------------|---------------|
| 1. Power | 2. Menu | 3. Home | 4. Navigational buttons | 5. Play/Pause |
| 6. Vol + | 7. Vol - | 8. Mouse | 9. Return | 10. OK |
| 11. Page + | 12. Page - | 13. Stop | 14. Keyboard | |

* Hold the "Fn" button to use the orange color keys.

* Hold the "shift" button to use the 3rd keys on the top right corner.

(ex. :, ", <, >, ?)

First Time Usage

Part 1: Power Up

1.1. When you power up the box for the first time, it will enter the setup wizard.

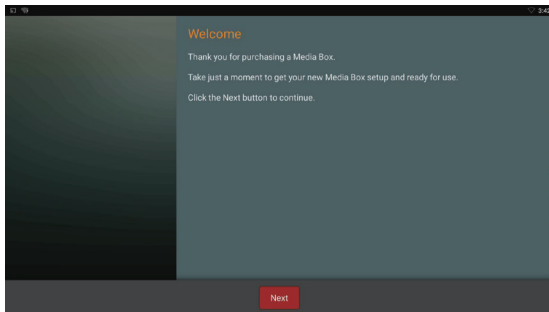

1.2. Select your language (Note: English is default).

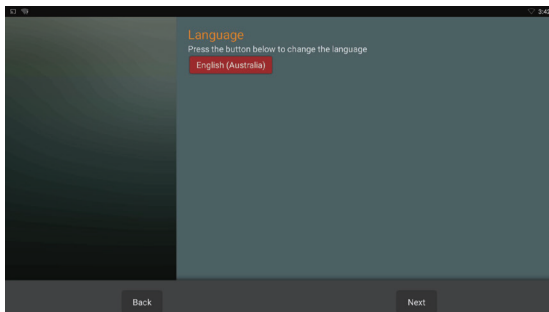

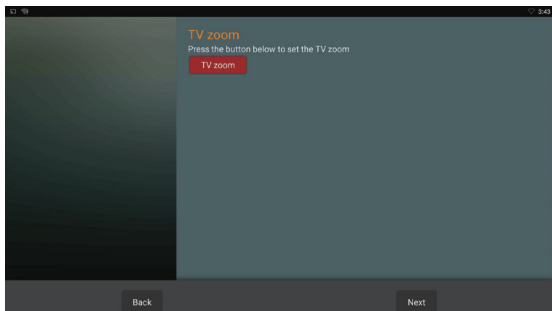

1.3. Adjust your screen position to fit properly onto your television or monitor.

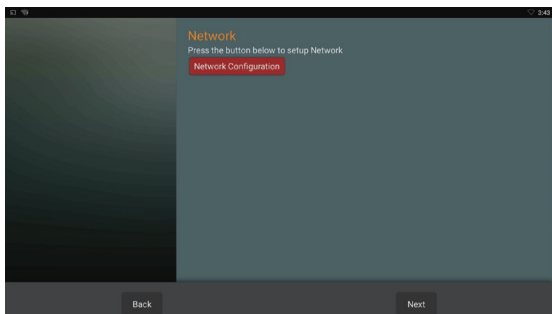

1.4. Setup your Wi-Fi or Ethernet connection.

1.5. Select “Finish”. You will be taken to Home Screen Selection.

1.6. Now that you are at the MyGica home screen, you can navigate through your favorite apps, or select “Applications” to bring you to the rest of your apps that are installed on this box. You can access the settings menu by selecting your navigation button either to the left or right while the cursor is turned off.

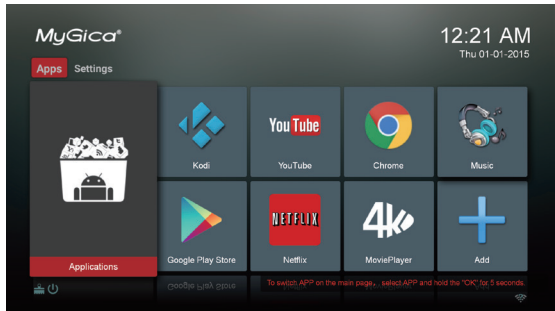

1.7. To change Favorite apps, just select the APP you want to change, then press and hold the OK button and you will see a list of all of the installed apps.

App's with a “star” are the apps that are listed as your favorites on the home screen. Select an app without a “star” to add that app to the home screen.



Part 2: How to change your settings

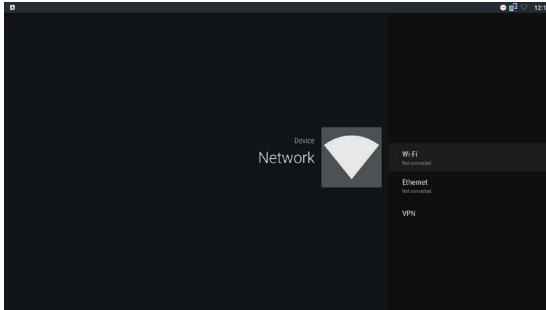
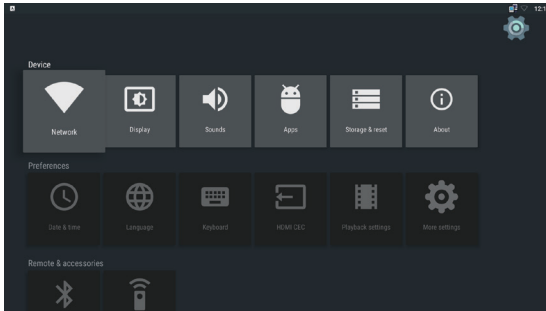

2.1. The settings menu includes all the basic settings for the ATV329X if you want to access all other settings for the Android system, just select “More Setting”. This will take you into the native Android settings Menu.

2.2. Network Setup

In this menu you can setup Wi-Fi and Ethernet network.

2.2.1. Setup Wi-Fi

Select Wi-Fi then all the available Wi-Fi networks in your area will be scanned. Connect to the Wi-Fi network that is available to you.

If connecting to a secured Wi-Fi network, the corresponding password will be required, otherwise you will receive a “failed to connect” message and need to re-enter the password.

2.2.2. Setup Ethernet

First plug in your LAN cable then select Ethernet. Make sure to select “Ethernet” to the “on” position. It will then auto detect your network and give you the ip address assigned to your box.

2.3. Display Settings

In here you can change the screen resolution, screen position, screen rotation and Daydream (screen saver)

2.3.1. Screen resolution

In here you can select your video output resolution.

Make sure the setting you choose is supported by your television before switching the output mode.

2.3.2. Screen position

You can use Zoom in or Zoom out to adjust the screen position to fit your television screen to your liking.

2.3.3. Daydream

In here you can setup screen saver when ATV329X is inactive for a period of time. You can show a clock, a color changing screen, or photo.

2.3.4. HDR

In here you can select to turn on or off display HDR option. By default it is set to Auto.

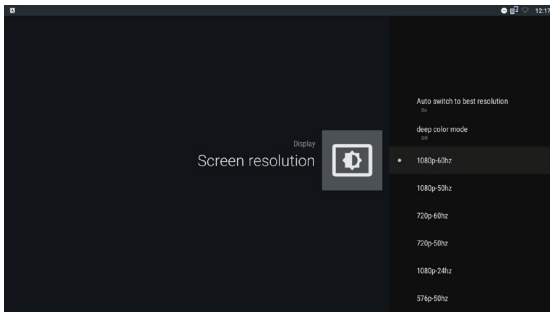
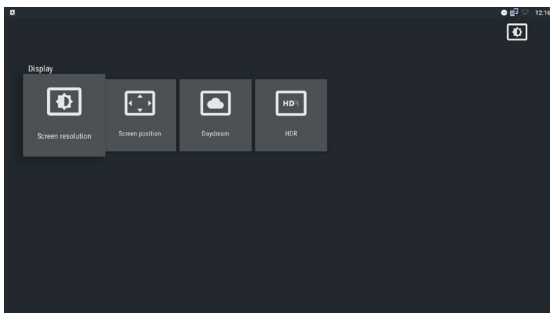

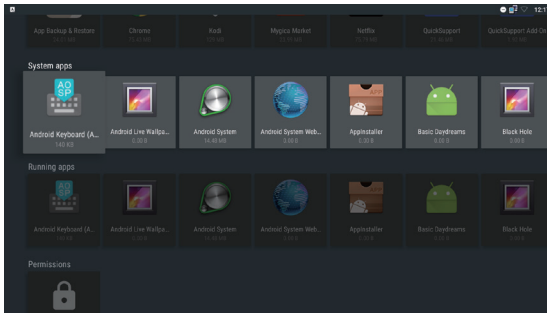

2.4. Manage applications

Navigate to “more settings” and then click on “Apps” at the top. This is where you can manage your applications that are on installed on the MyGica box.

The next column shows all the system applications. Unlike downloaded applications, these applications cannot be uninstalled.

Select one of the applications and click the ok button to enable you to:

1. Open the application (some applications that auto run in the background will not have this option.)
2. Uninstall the application (system applications do not have this option), this will also delete user data and saved games of the application.
3. Clear data: Delete any additional data this application has download or stored, some applications or games will not work properly if download data is deleted.

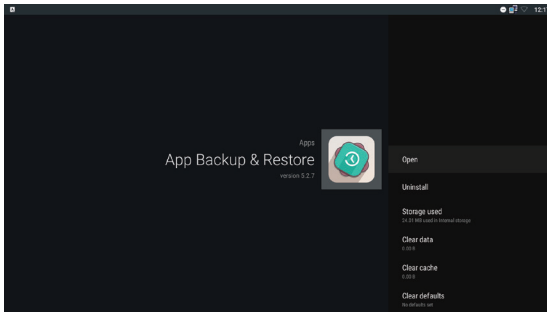

4. Clear cache: Delete the temporary files stored by this application.
5. Clear defaults: Clear default setup.
6. Select show or not show notifications from this application.
7. Show permissions of this application.

2.5. Date & time

In this menu you can setup the Date, Time, Time Zone and Time Display Format.

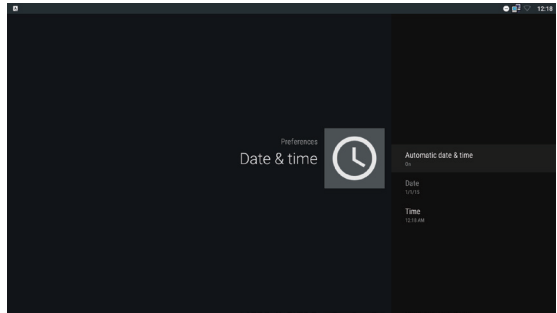

2.6. Language

In this menu you can change the system language to the language of your choice.

(Note: Default language is English)

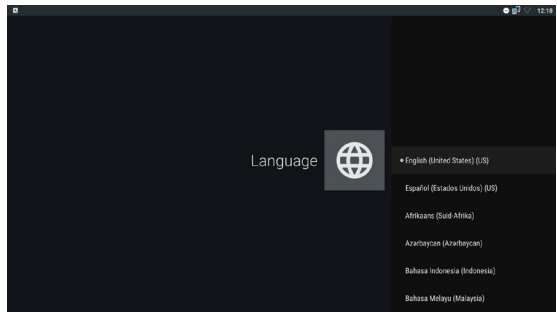

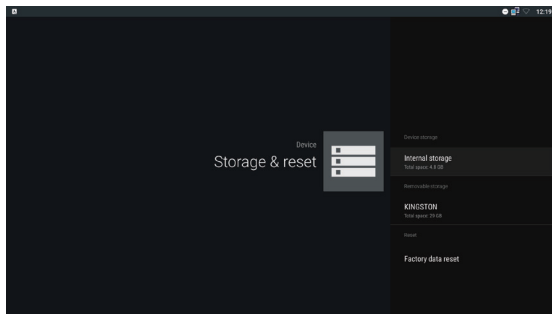

2.7. Storage & reset

Here you can check the storage usage of the internal storage. Any removable storage that is attached to the device (USB drive or TF card) will also be displayed. You can choose to safely eject the removable storage or format it to work as device storage.

If you want to restore all settings to factory default, just select Factory data reset. Once you select Erase everything, all user data will be deleted and all settings will go back to default settings.

Please take note, using this function will delete all user data and all user installed apks and it is not recoverable.

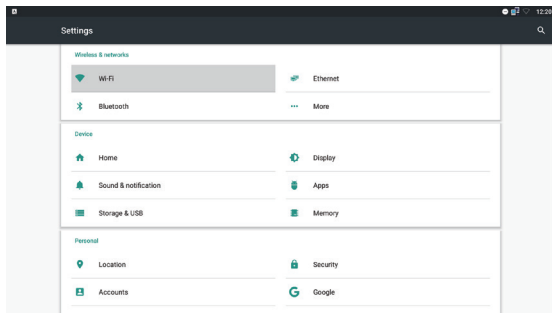

2.8. More Settings

You can access the original android settings in More setting.

3.0 App Market Places

You can find and install more applications by using the following market places already pre-installed on your MyGica.

- 1 - Google Play Store
- 2 - MyGica Store



4.0 KODI Media Center

KODI Media Center allows you to play and view most videos, music such as free podcasts from the internet, and all common digital media files from local and network storage media.

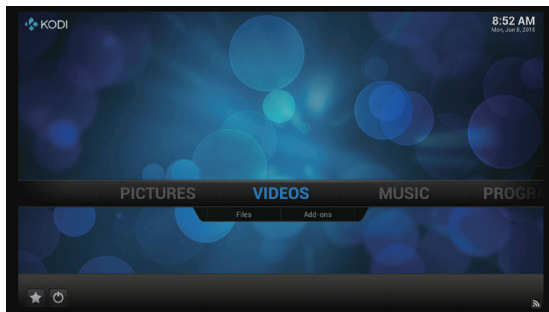

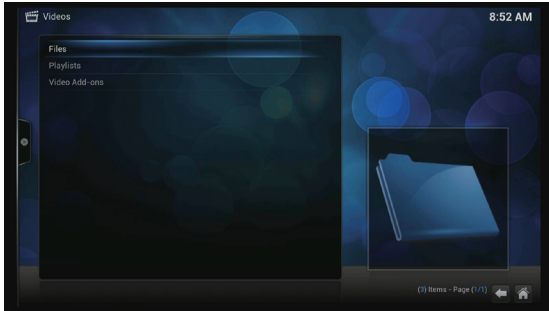

4.1 Playback local media files
Under Videos (same as Music and Pictures) there are 2 options, Files & Add-ons. To playback local media files, select 'Files' and enter Files interface, as shown in the picture:

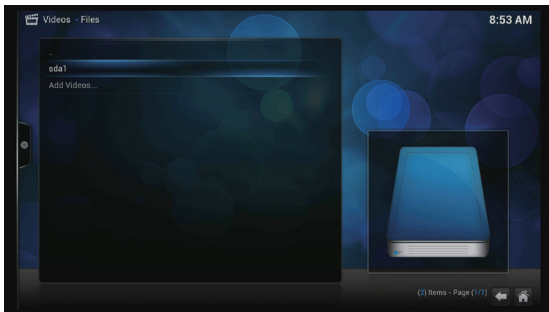

Select 'Files' and if you have connect a USB storage device or a SD card, you will see "sda1" or "sdcard" (depends on the storage device you use). Select it and Kodi will list out all files within the storage device. You can then select a media file and start watching it.

4.2 Playback media from internet

KODI comes with some free internet podcast channels, to view these channels, goto Videos (or Music) and select Add-ons.

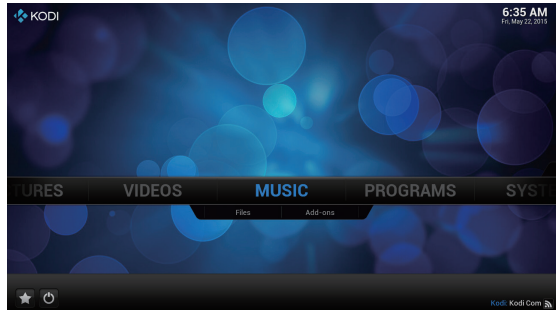

Once you enter Add-ons, you will see a list of different channels. These channels are in alphabetical order, browse through the list and select the desire channels and start playback the internet media.

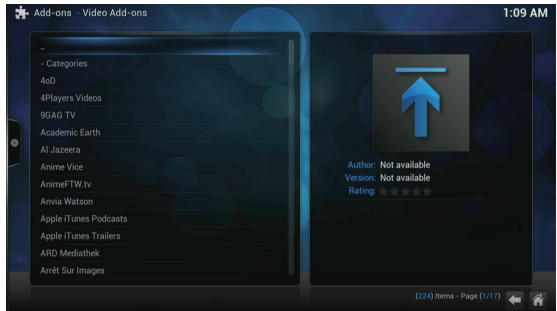

Congratulations!

This completes the first time setup process of your brand new MyGica.

For technical support please visit our website <http://www.mygicasupport.com>

TECHNICAL SUPPORT

Online Support

www.mygicasupport.com

Wiki

wiki.mygica.tv

Email Support

support@mygica.tv

CALL TOLL FREE

1-855-MYGICA-8 (694-4228)